

6452 Walnut Hill.

01.06.2025



6452 WALNUT HILL INTERIOR DESIGN

Final



NAME OF COMPANY
CH - Design Studio

PRESENTED BY
Alejandra Mora

KITCHEN

Final

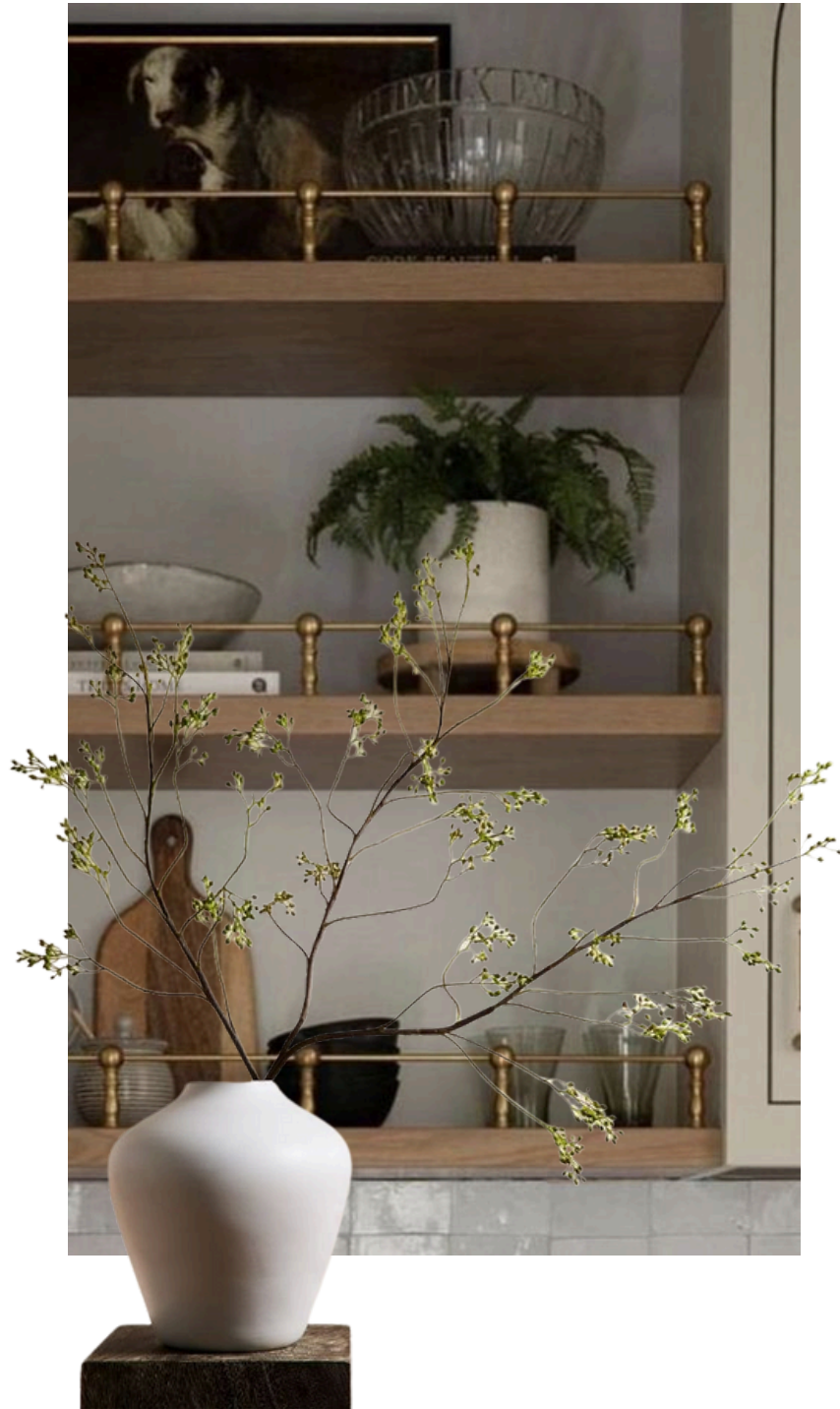

KITCHEN

Final

FAUCET



PENDANT
LIGHTING



PENDANT
LIGHTING

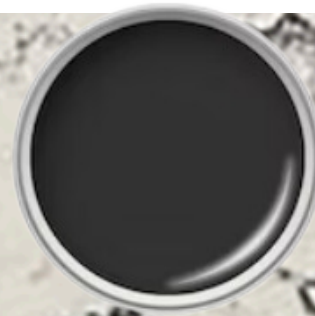

CABINET
HARDWARE

BACKSPLASH
AND
COUNTERTOP



UNDERMOUNT
SINK



CABINET



KITCHEN

Floorplan New Option

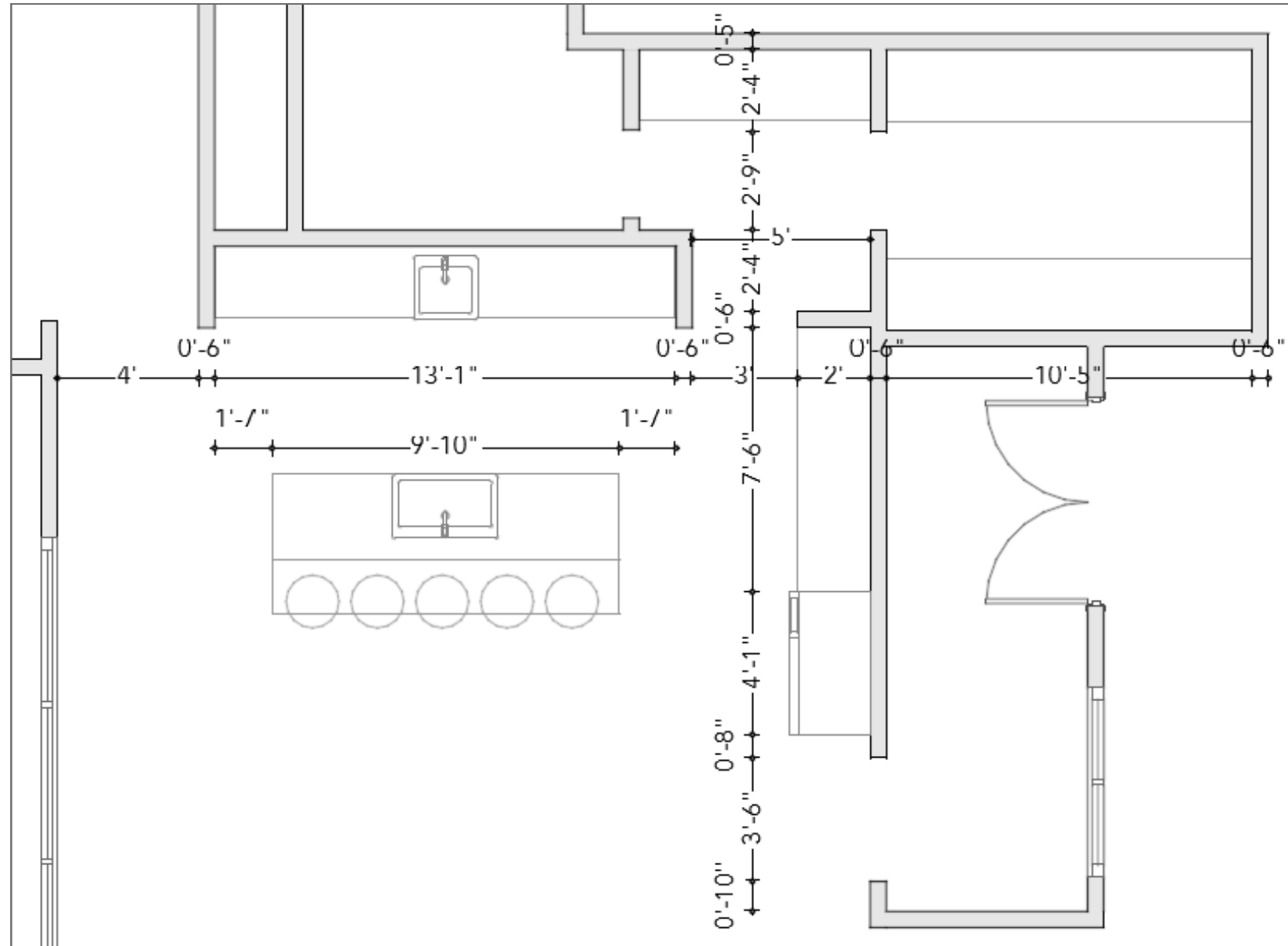

KITCHEN

Inspo 1 - New Option



KITCHEN

Inspo 1 - New Option



KITCHEN

Inspo 1 - New Option



KITCHEN

Inspo 1 - New Option



KITCHEN

Inspo 1 - New Option



DINING ROOM

Inspo 1 - New Option



DINING ROOM

Inspo 1 - New Option



KITCHEN

Inspo 1 - New Option



KITCHEN

Inspo 1 - New Option



KITCHEN

Inspo 1 - New Option



KITCHEN

Inspo 1 - New Option



DINING ROOM CABINET

Inspo 1 - New Option



FOYER

Inspiration

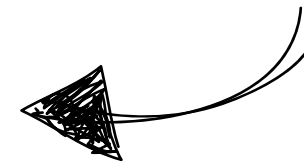
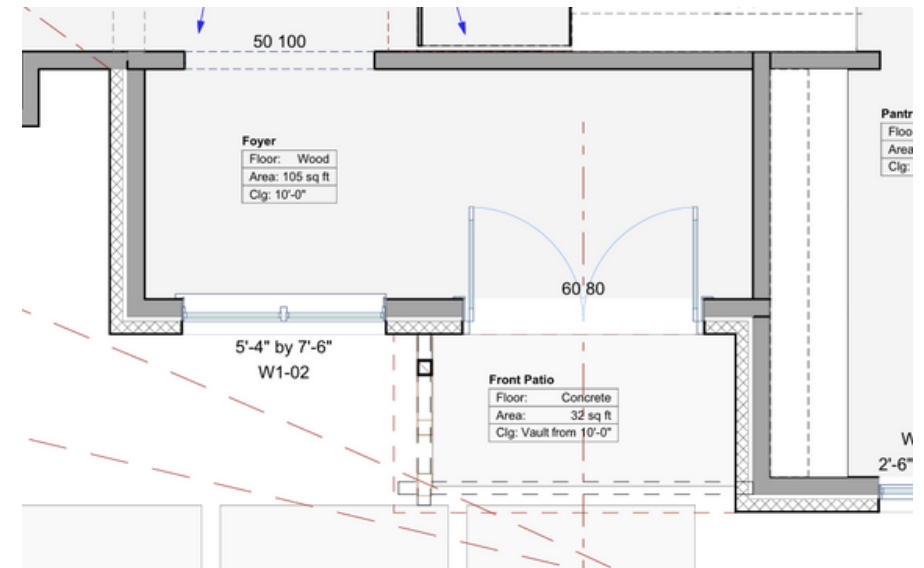

Herringbone in Foyer Perimeter.

LIVING ROOM

Inspo



Fireplace Mantle
Cast Stone



White oak built ins

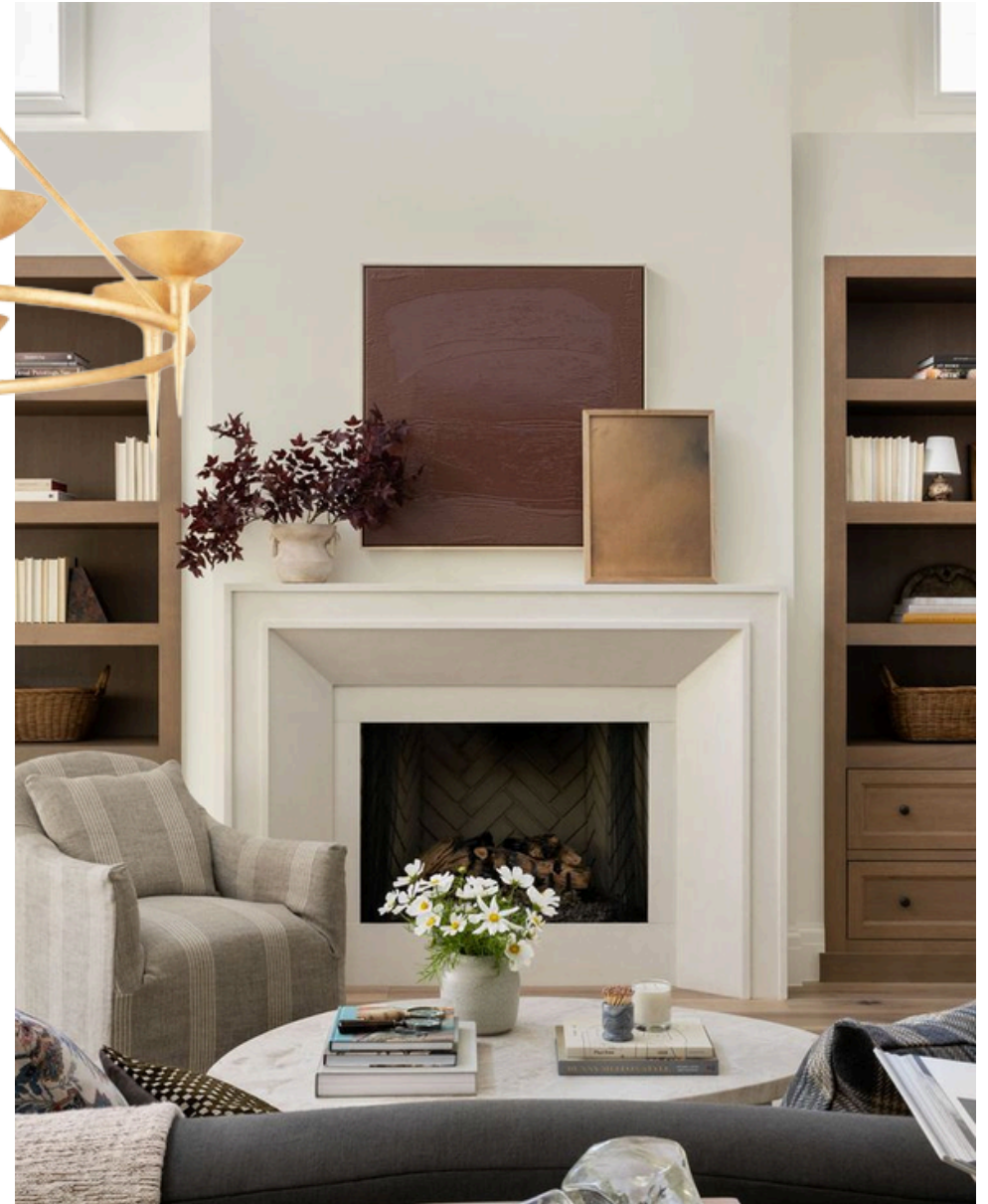

STUDY

Inspiration



Herringbone

floors

Moody Wall

color

black door with

glass

LIGHT FIXTURES

Chandeliers

Study



Fireplace Sconce



LIGHT FIXTURES

Chandeliers

Dining

1



Living Room



MASTER BATHROOM

Final

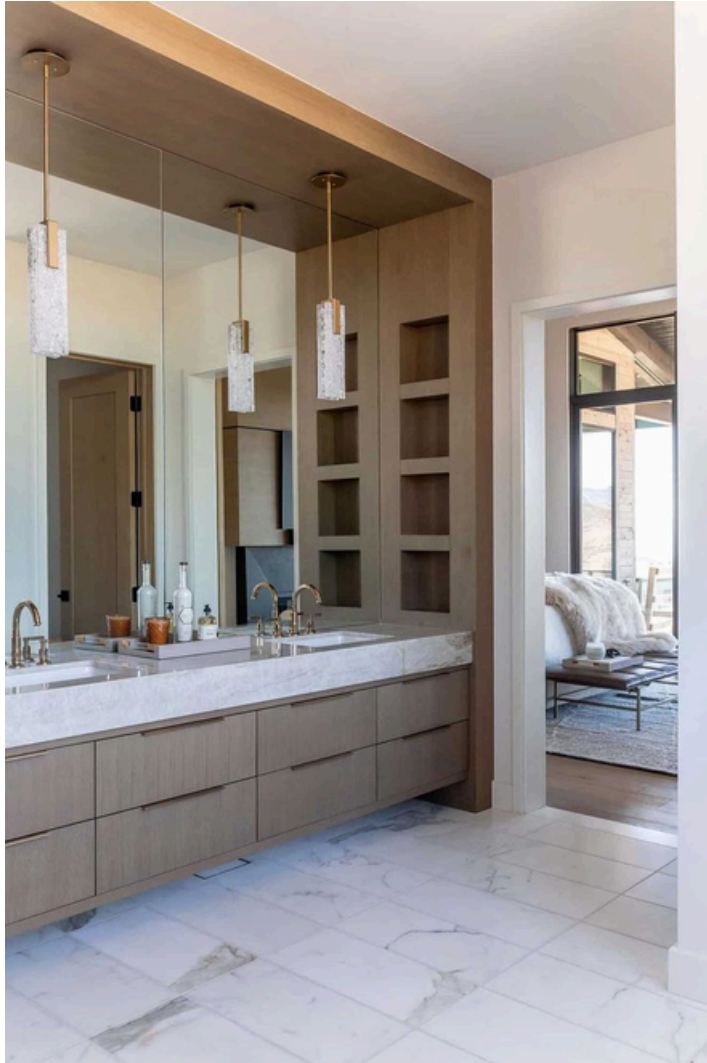

VANITY TO BE FLOATING
SURROUND THE PERIMETER WITH
OAK PANEL
MITERED EDGE COUNTERTOPS



24*24 LIMESTONE LOOK TILE

MAIN WALL 17*47 CHEVRON TILE



CABINET STAIN

MASTER BATHROOM

Final



VANITY TO BE FLOATING
FLAT PANEL DRAWERS
RIFT CUT WHITE OAK
MITERED EDGE COUNTERTOPS 4'' THICK

WALL MOUNT VANITY FAUCETS SHOULD PLACED AT
42'' FROM
THE
FLOOR AND 48'' DISTANCE FROM VALVE TO VALVE .

TILE LAYOUT

Master Bathroom
Final



Main Wall to be covered in the wood look tile

Side walls of the shower enclosure to be covered with the 32*32 Thadeus white

Main Wall: Briona Brown
18" x 48".
Layout: Vertical Stack
Grout: Harvest

Bathroom Floor:
Thaddeus White 32" x 32".
Layout: Stacked
Grout ; Frost

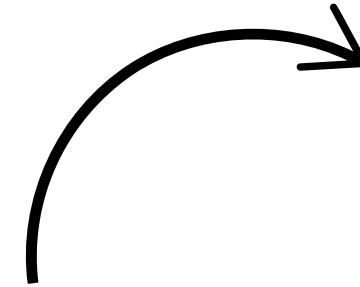

Shower Floor: Thaddeus
Mosaic White 4" x 4".
Layout: Mesh
Grout: frost

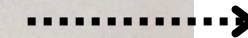

GUEST BATH SHOWER

Inspo 2



GUEST BATH SHOWER

Inspo 2



VANITY TO WHITE OAK

MICRO SHAKER 0.50''
WITH A REEDED DETAIL BAND ON
FIRST SET OF DRAWERS.

TILE LAYOUT

Guest Bath Shower
Final

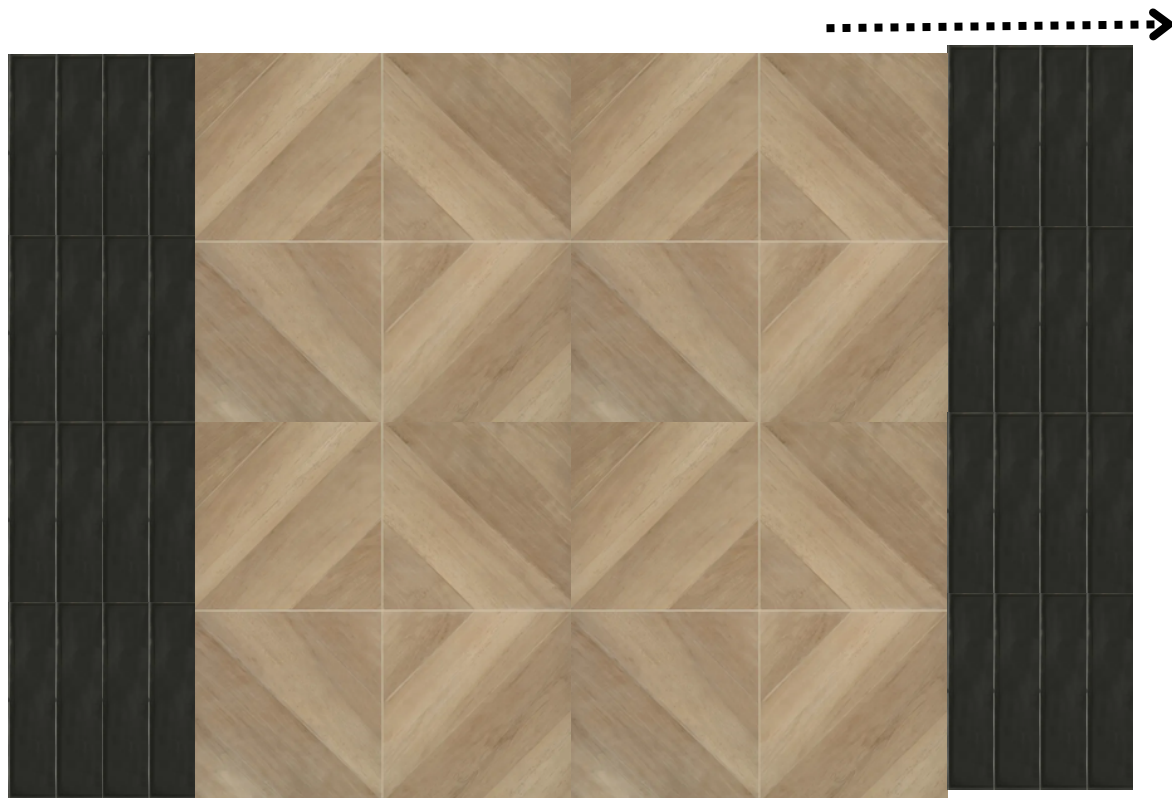

Wood look tile for Main Wall

Grout : Harvest

Black Subway for side walls

Layout : Vertical Stack

Grout : charcoal

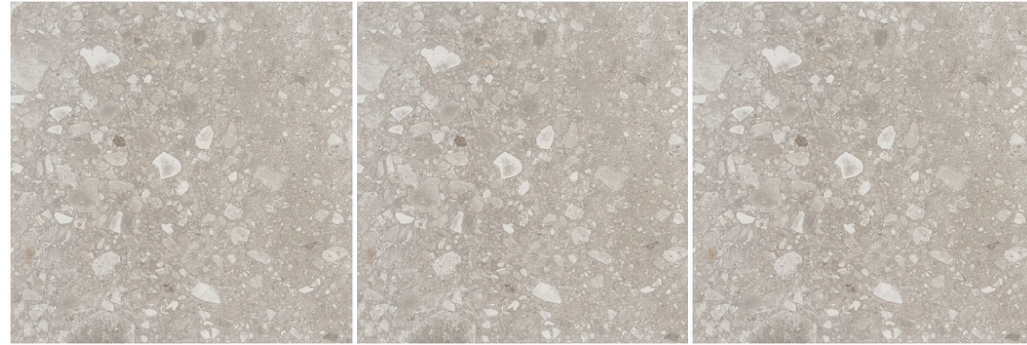

Shower Floor: Frammenta
Mosaic White 12" x 12".

Layout: Mesh

Grout: Alabaster

Bathroom Floor: Frammenta 24"
x 24" White.

Layout: Stacked

Grout: Alabaster

BATH 2 TUB

Final

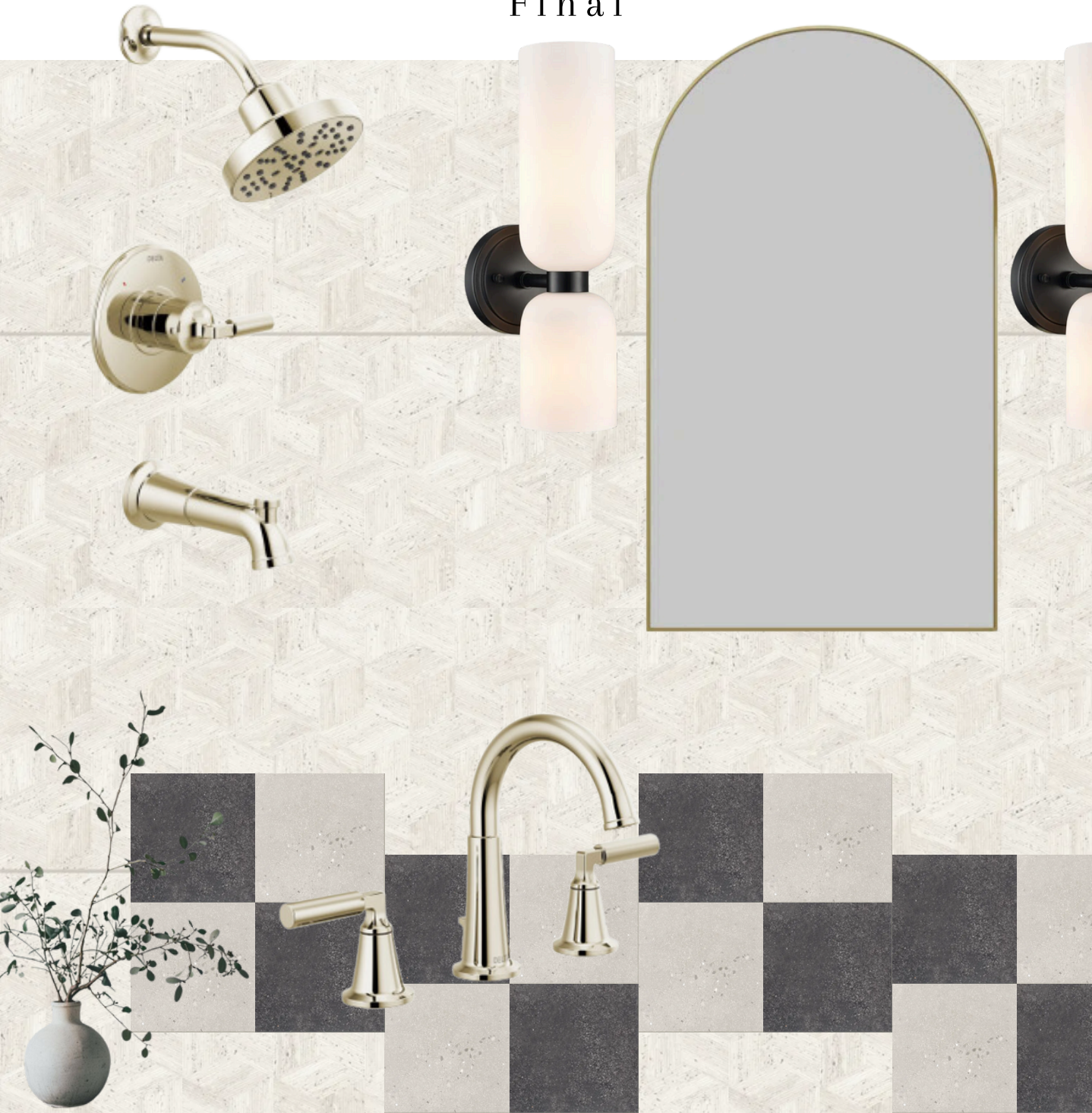

TILE LAYOUT

Bath 2 Tub
Final



Wall: Sensi Roma 24" x 48" White.
Layout: Stacked
Grout: Alabaster

Bathroom Floor: Area 12" x 12"
Black and Clay.
Layout: Chekered Pattern
Grout: Alabaster



BATH TUB

Vanity

VANITY TO BE PAINT GRADE

SEMI OVERLAY

DOOR STYLE : 1.50'' SHAKER
TWO DOORS IN SINK AREA TO BE
REDED

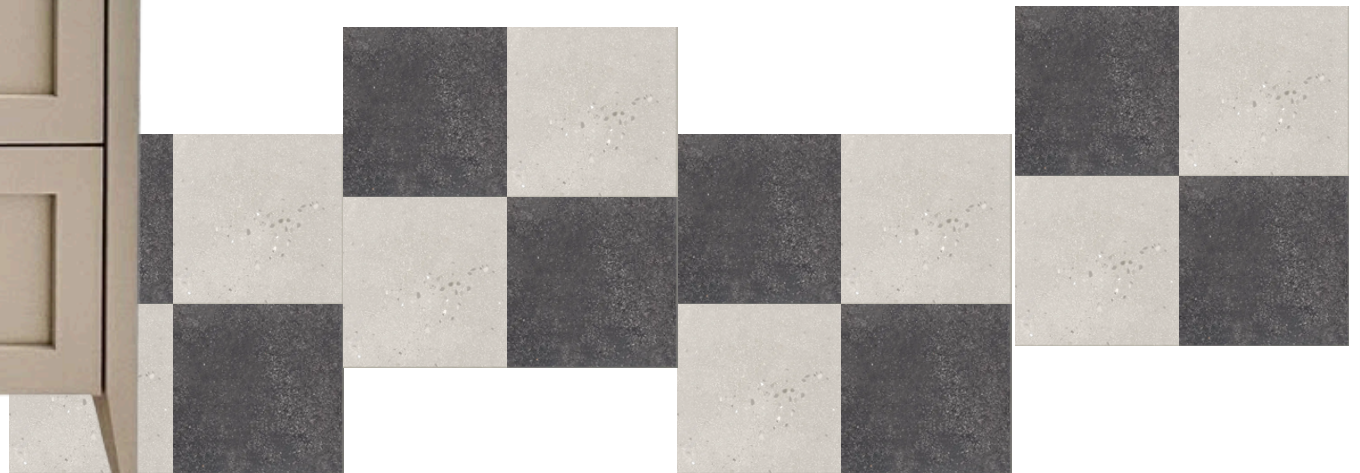

BATH 3 SHOWER

Final



TILE LAYOUT

Bath 3 Shower
Final



Green Paint 3" x 16"
Main Wall
Vertical Stacked
Layout and Grout
Alabaster



Travertine 12" x 12"
White for Shower
Floor
Layout Mesh
Grout Alabaster

Travertine 12" x 24"
White for Bathroom
Floor



Layout Stack
Grout Alabaster

VANITY DESIGN

VANITY TO BE PAINT GRADE

SEMI OVERLAY

DOOR STYLE : 1.50" SHAKER

TWO DOORS IN SINK AREA TO BE
REEDED

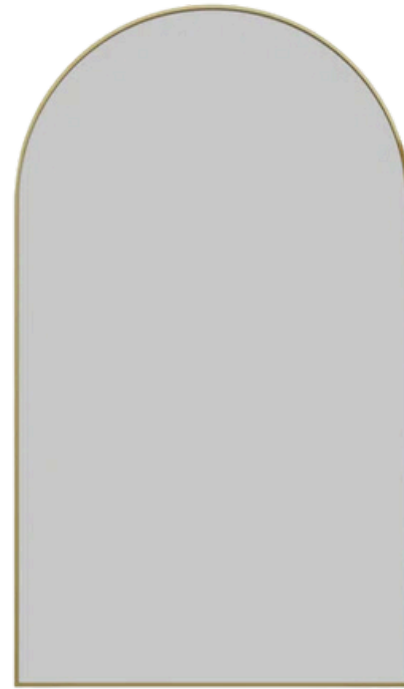

SHERWIN WILLIAMS

Accessible Beige



BATH 4 TUB

Final

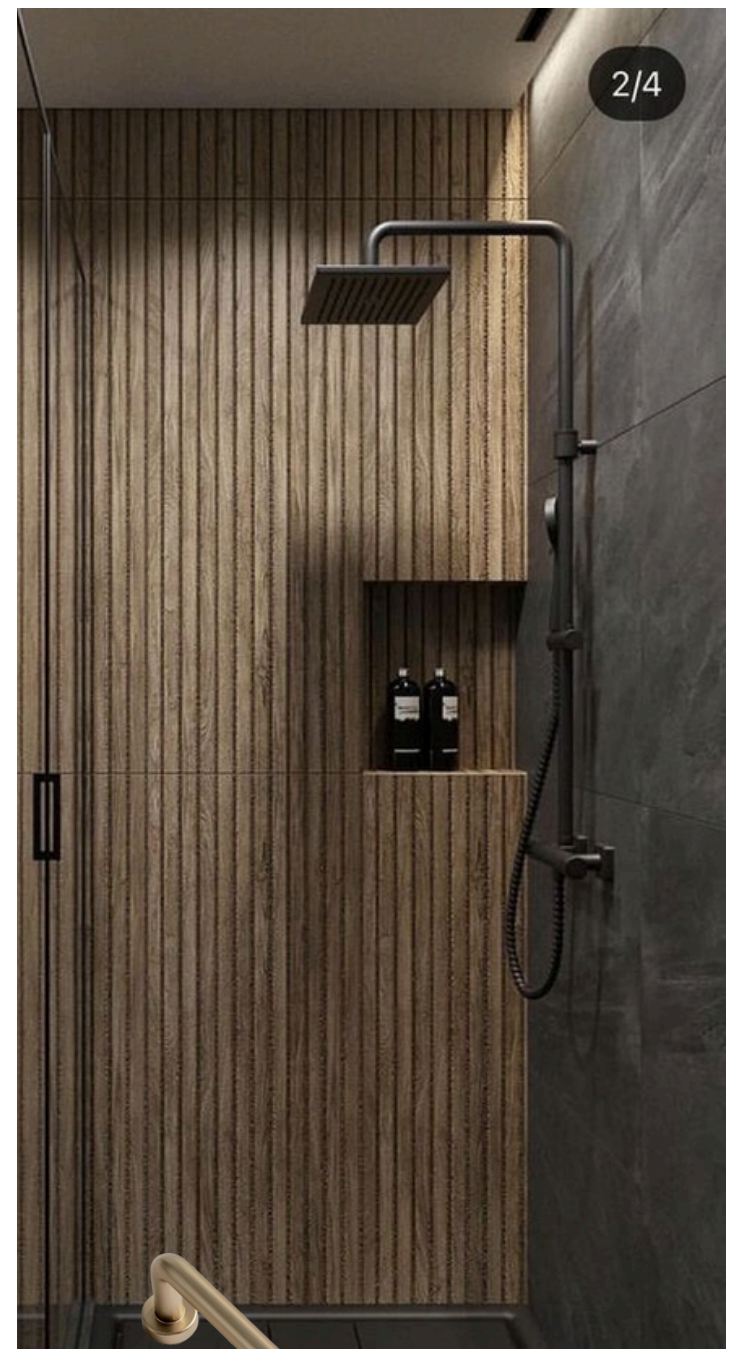

TILE LAYOUT

Bath 4 Shower
Final



Ribbon Wood
Look 16" x 48"

Maple Main Wall
Grout : Harvest

Nomade 24*48
in color Argent
for side walls
Grout : Alabaster

Bathroom Floor: Nomade Argent
12" x 24".

Layout: Stacked
Grout: Alabaster

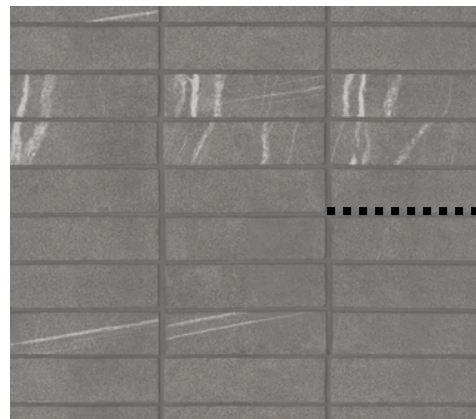

Shower Floor: Nomade
Argente Mosaic 1" x 4".

Layout: Mesh
Grout: Alabaster

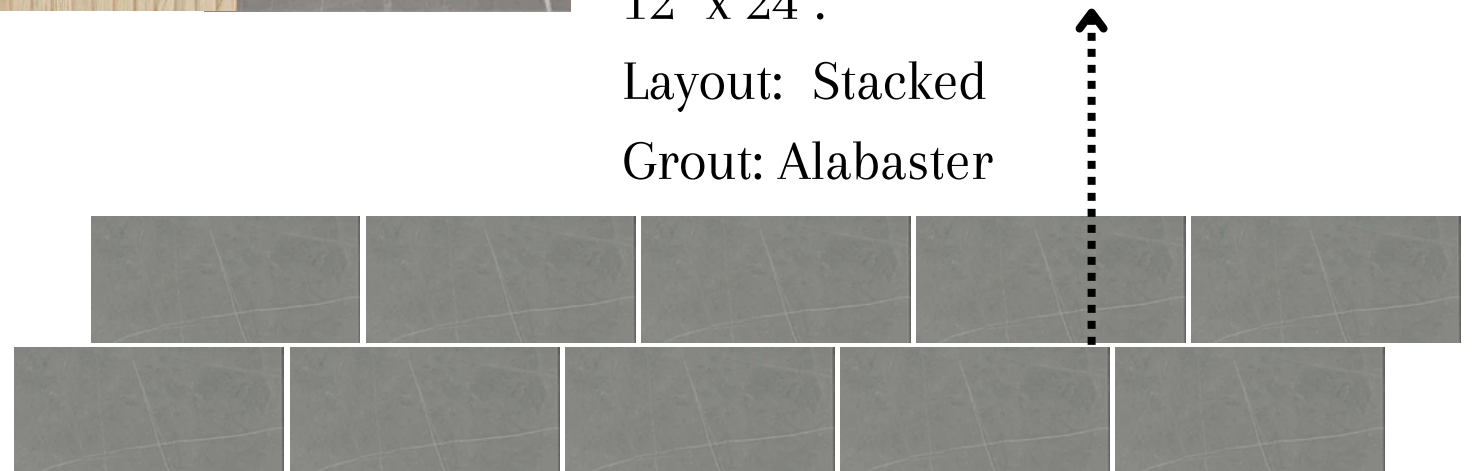

VANITY DESIGN

VANITY TO BE PAINT GRADE

SEMI OVERLAY

DOOR STYLE : 1.50'' SHAKER

TWO DOORS IN SINK AREA TO BE
REDED



LAUNDRY/MUDROOM

Final

Lockers

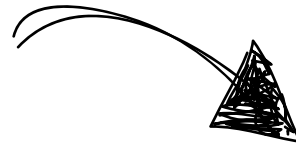

TILE LAYOUT

Laundry
Final

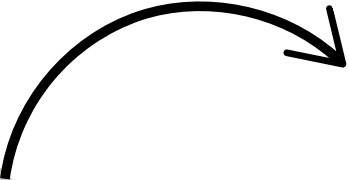
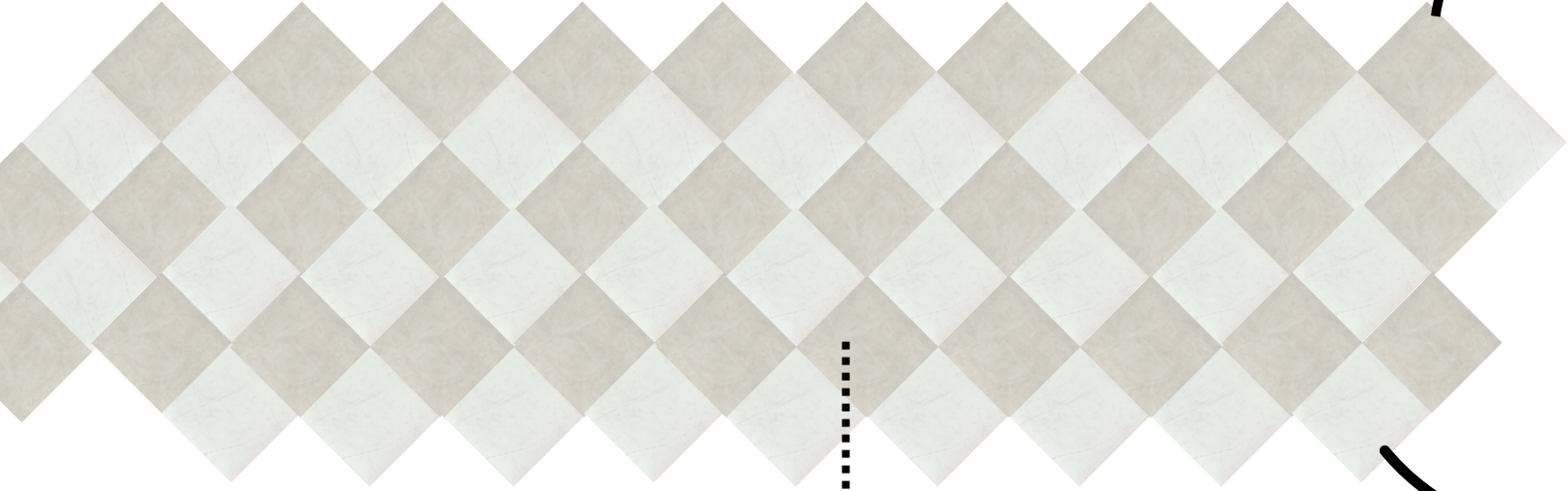

Sterlina 24" x 24"
Silver and White
Chekered Pattern
Floor

Grout : Alabaster



POWDER ROOM

Final

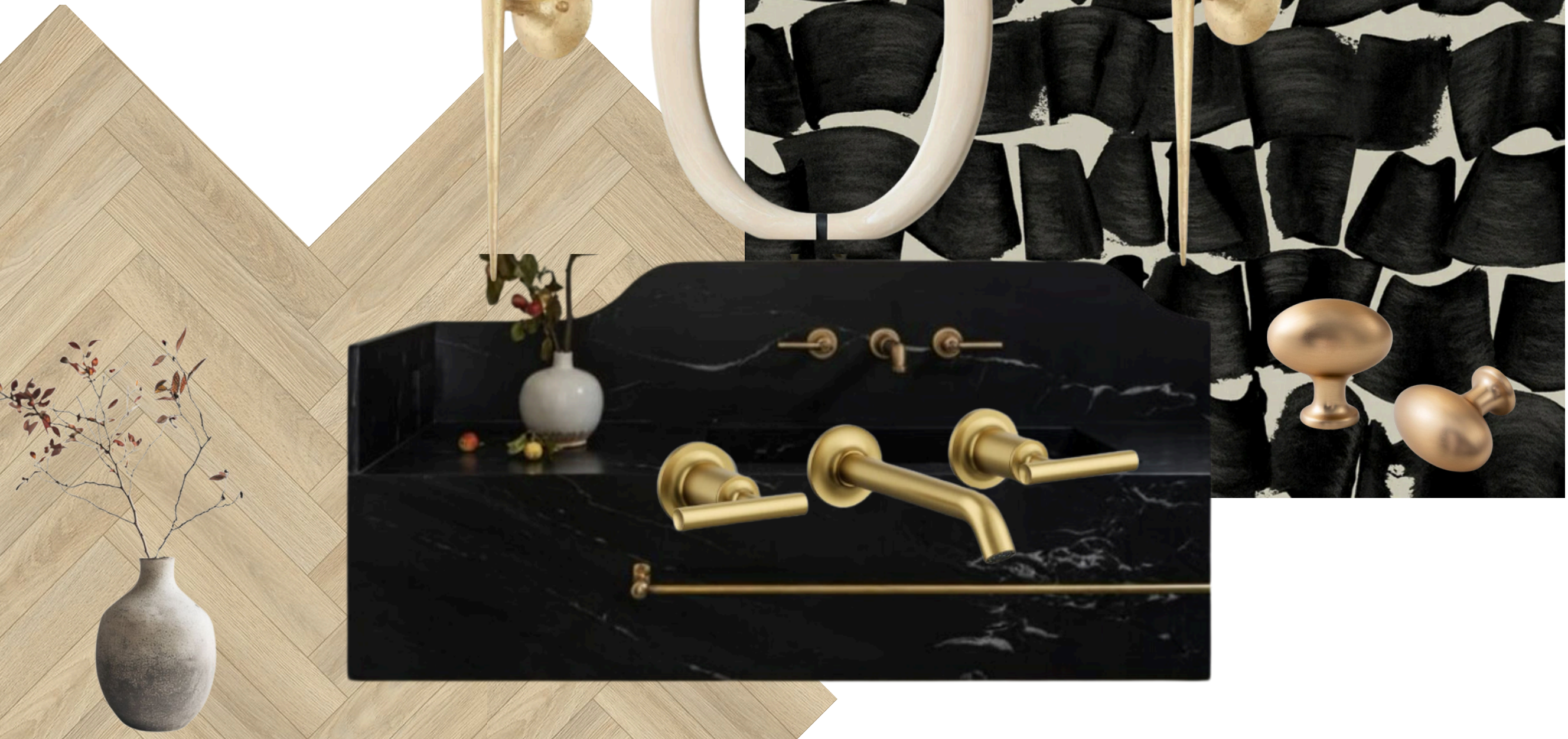

6452 Walnut Hill.

02.21.2025



6452 WALNUT HILL INTERIOR DESIGN

Cabinetry

NAME OF COMPANY
CH - Design Studio

PRESENTED BY
Alejandra Mora

KITCHEN

Inspo 1 - New Option

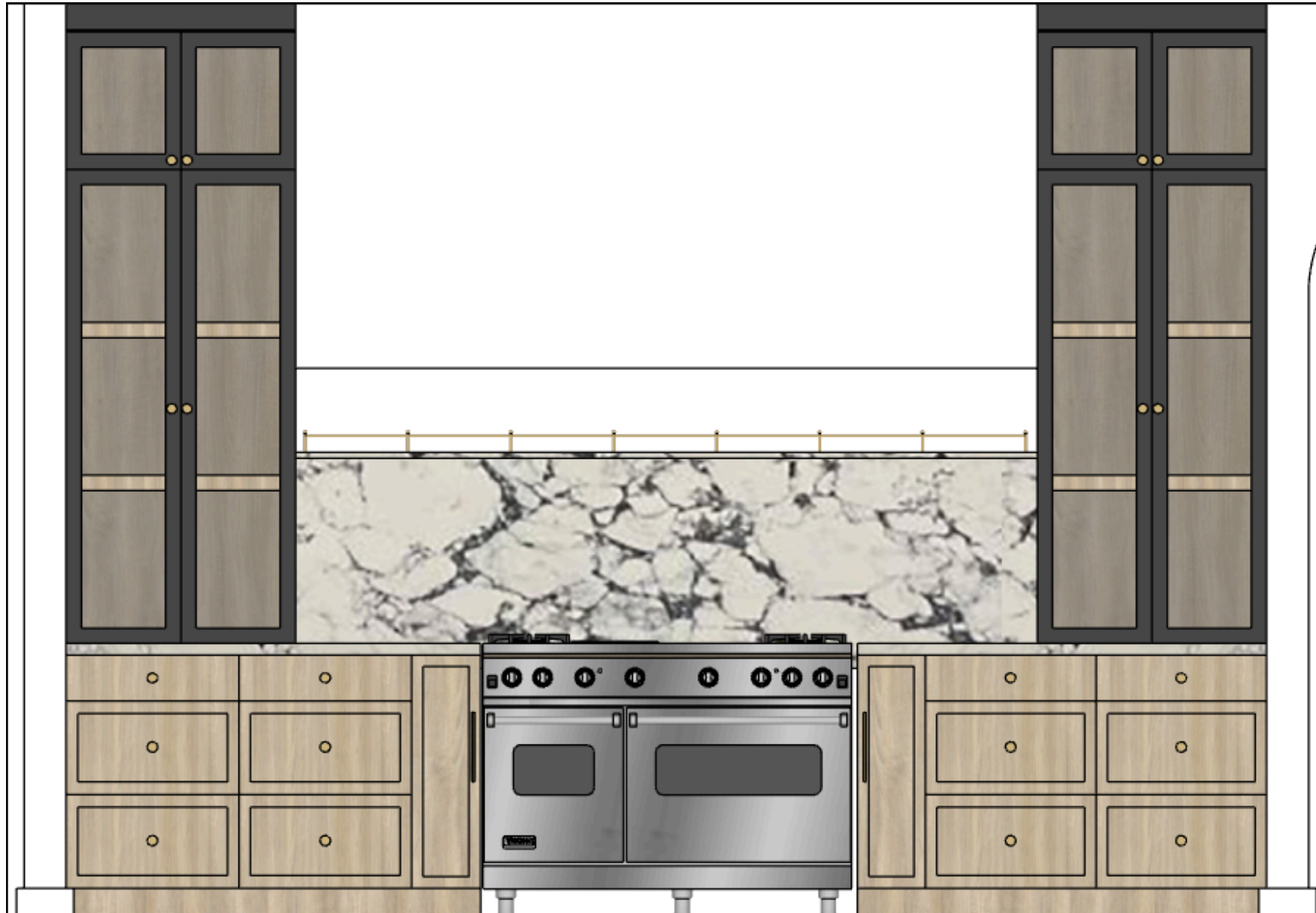

Main Wall Cabinets

Style : Inset

Door profile : 1" Mini Shaker

Upper cabinets : Interior White oak
Glass dor with black frame (paint grade)

KITCHEN

Inspo 1 - New Option

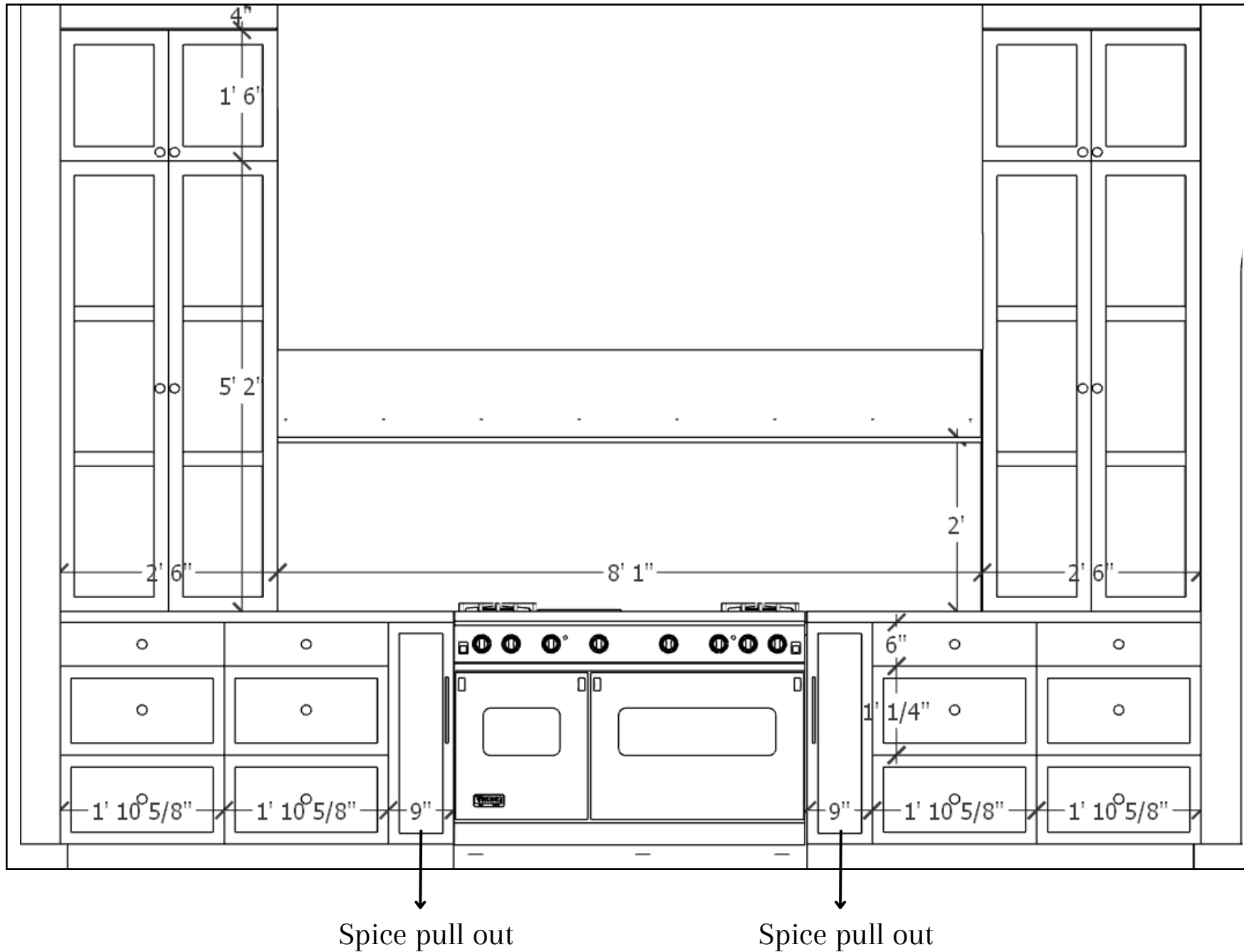

Inspo for Venthood

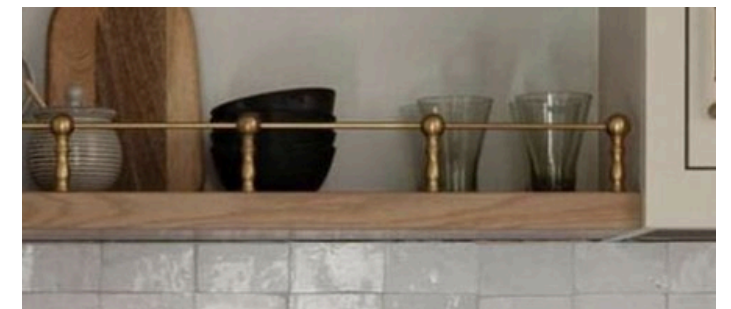

Detail of shelf

KITCHEN

Inspo 1 - New Option



Kitchen island in white oak

Style : Inset

Door profile : 1" mini Shaker

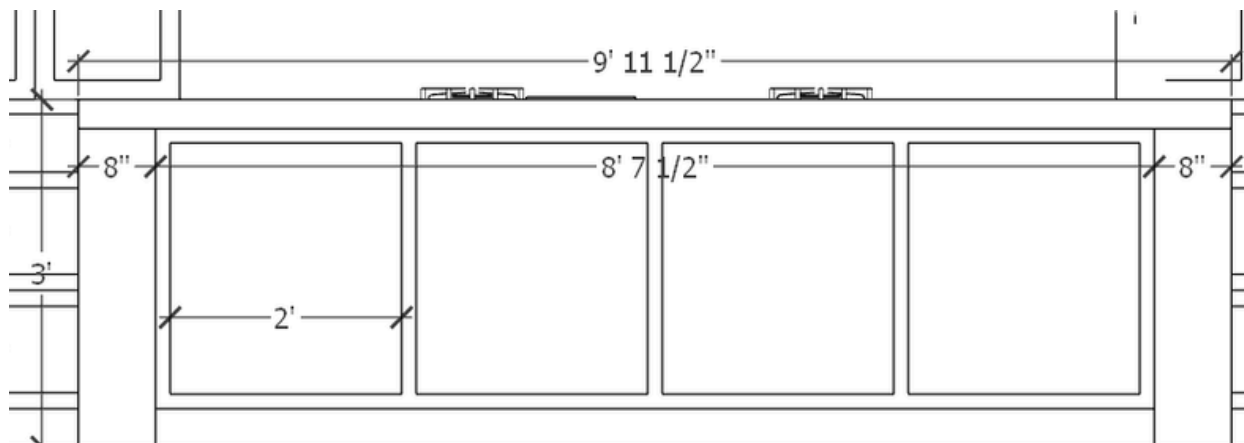

KITCHEN

Inspo 1 - New Option

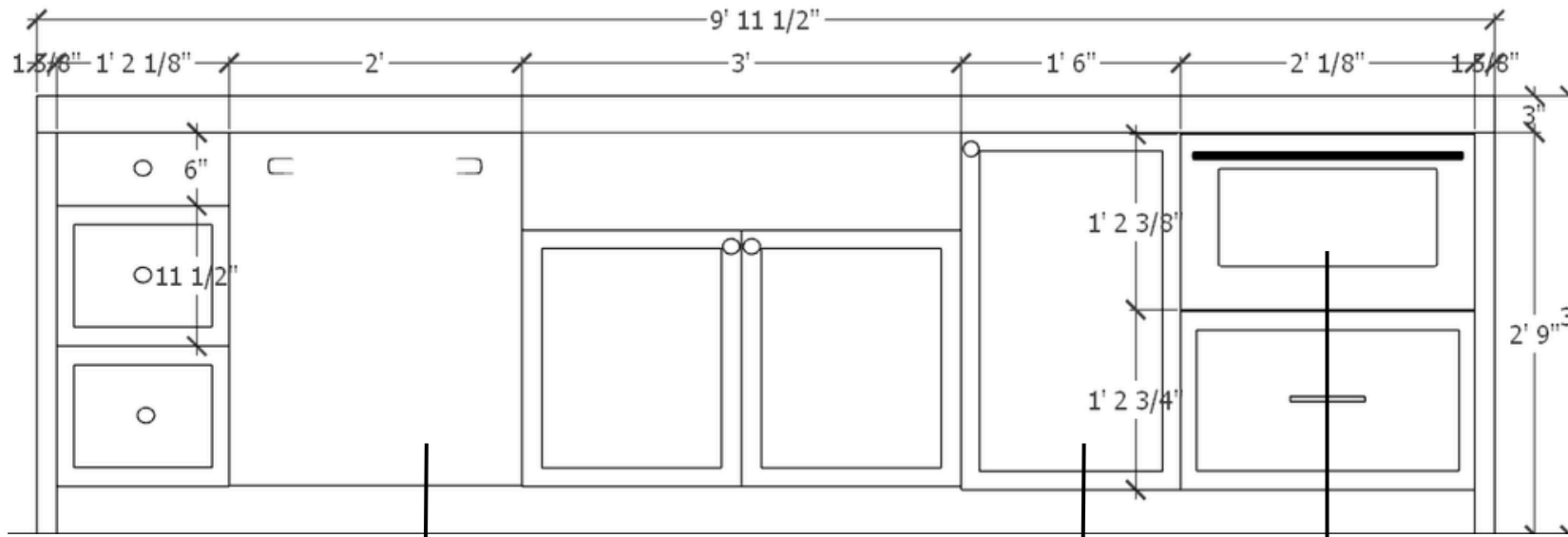

Dishwasher

Trash pull out Microwave

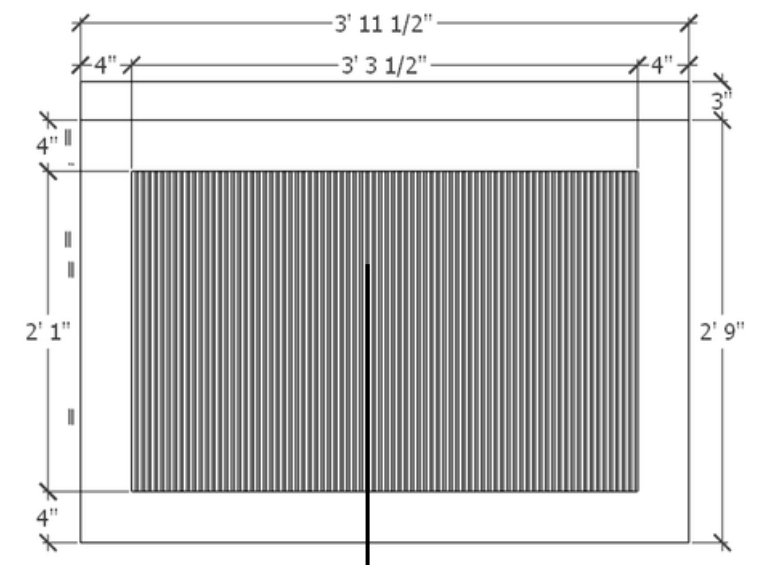

Reeded island

KITCHEN

Inspo 1 - New Option

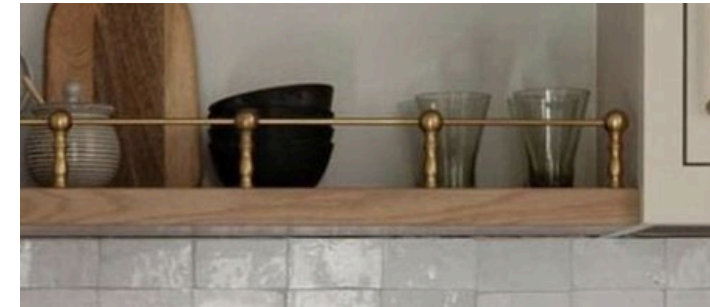

Detail of shelf 2"



Fridge wall in white oak

Style : Inset

Door profile : 1" mini
Shaker

Upper cabinets : Interior
White oak

Glass door with black
frame (paint grade)

KITCHEN

Inspo 1 - New Option

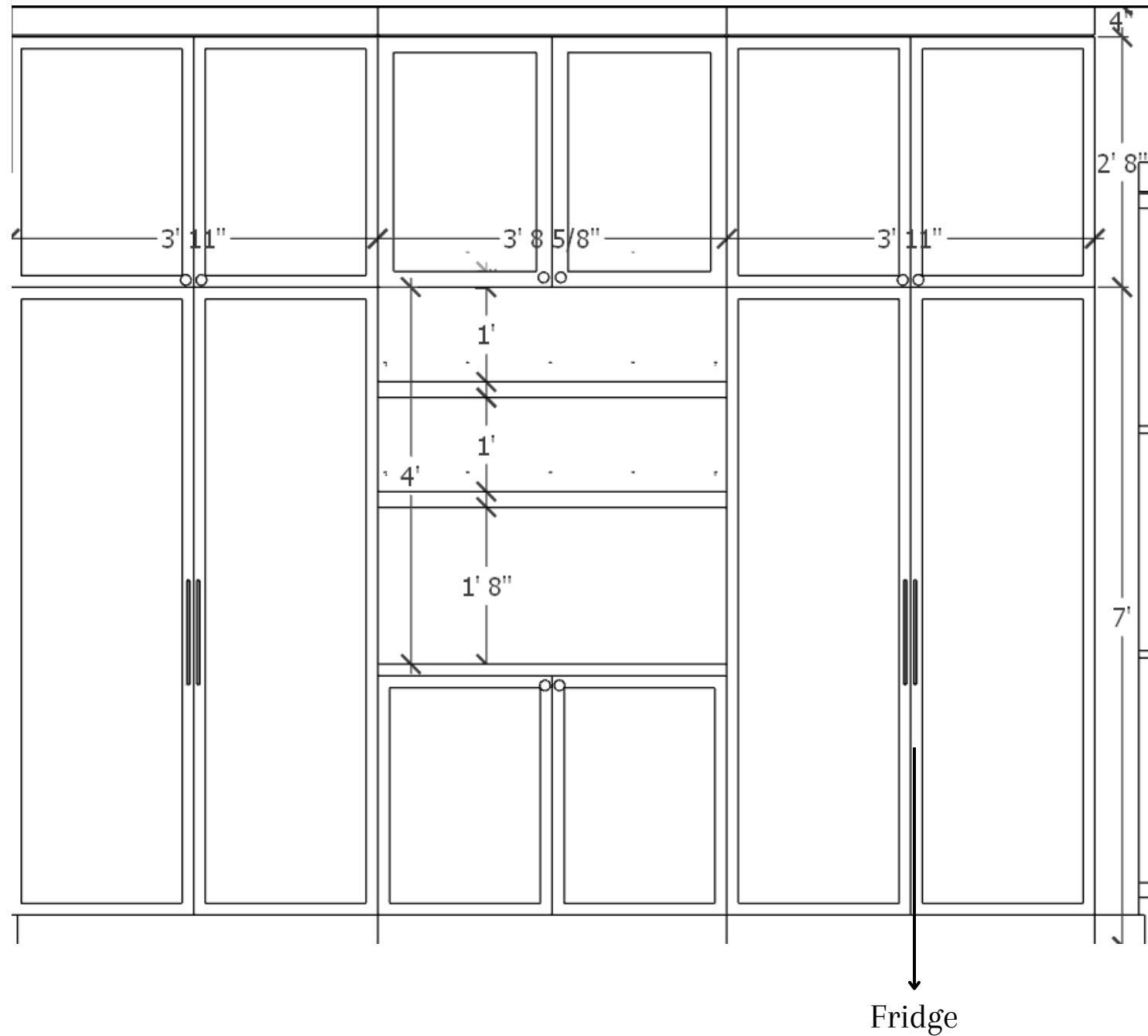

DINING ROOM

Inspo 1 - New Option

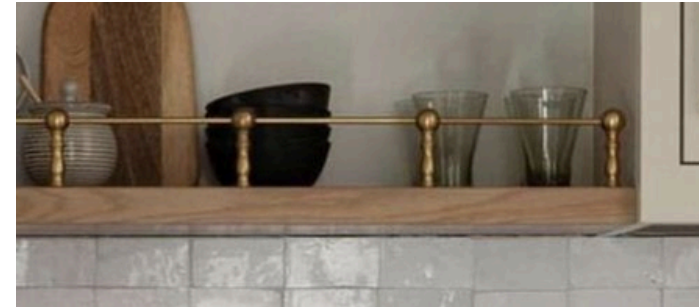

Detail of shelf 2"



Dining room in white oak

Style : Inset

Door profile : 1.5" Shaker

Upper cabinets : Interior White oak
Glass dor with black frame (paint grade)

DINING ROOM

Inspo 1 - New Option

